

HEDCON[®]

Worm Gear Reducer

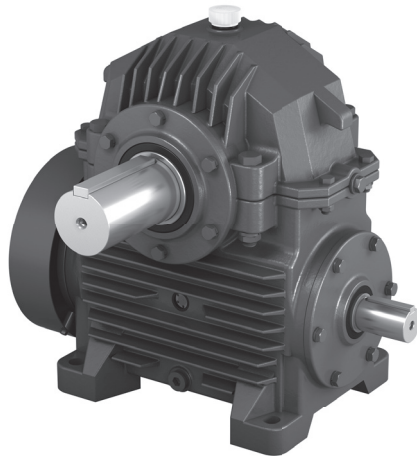

《CAUTION》

- These products should be handled, installed, and maintained by trained technicians. Carefully read the maintenance manual before use.
- Oil is removed from these products before shipment. Supply oil according to the maintenance manual before operation.
- A copy of this maintenance manual should be sent to the actual user.
- This maintenance manual should be kept by the user for future reference.

Introduction and safety

- Read these instructions and all accompanying documents carefully prior to installing, starting, operating, inspecting, and maintaining this equipment in any region worldwide. The equipment must meet all conditions relating to safety as noted in this instruction prior to starting and operating. These instructions must always be kept close to this equipment's operating location or directly with the product.
- These instructions contain specific safety markings. Failure to observe and follow the safety precautions marked in these instructions creates a high risk to equipment or property damage, a high risk to personal safety and/or death.



This symbol indicates safety instructions where non-compliance will involve a high risk to personal safety or loss of life.



This symbol indicates safety instructions where non-compliance will affect personal safety and can result in the loss of life.

DANGER

- Transport, installation, plumbing, operation, maintenance, and inspections should be handled by properly trained technicians; otherwise, injury or damage to the machine may result.
- When the unit is to be used in a system for transport of human beings, a secondary safety device should be installed to minimize chances of accidents resulting in injury, death, or damage to the system.
- When the unit is used for an elevator, install a safety device on the elevator side to prevent it from falling.
Otherwise, serious injury, death, or damage to the elevator may result.

CAUTION

- Please install loss prevention device such as oil pan to the machine which is vulnerable to oil especially (machine for food processing and machine for clean room, and so on) in case oil or grease leaks; otherwise, the product may fail because of oil leakage.

Refer to the CYCLO maintenance manual (No. CM2001E) for the handling of CYCLO portion of **gearmotors and reducers with CYCLO** .
Refer to the three - phase squirrel cage induction motor manual (No. MM1001E) for the handling of **gearmotors with a three - phase motor** .

— CONTENTS —

Introduction and safety 1

1. Inspection upon delivery 3

2. Storage 6

3. Transport 6

4. Installation 7

5. Coupling with other machines 8

6. Operation 10

7. Daily inspection and maintenance 12

8. Disassembly and assembly 15

9. Troubleshooting 15

10. Construction drawing 16

11. Warranty 17

1. Inspection upon delivery



CAUTION

- Unpack the unit after verifying that it is positioned right side up; otherwise, injury may result.
- Verify that the unit received is in fact the one you ordered. When a different unit is installed, injury or damage to the equipment may result.
- Do not remove the rating plate.

Upon delivery and receipt of the reducer check the following. If a nonconformity or problem is found, contact our nearest agent, distributor, or sales office.

- (1) Do the items on the rating plate conform to what you ordered?
- (2) Was there any part broken during transport?
- (3) Are all bolts and nuts tightened firmly?

1-1) How to refer to the rating plate

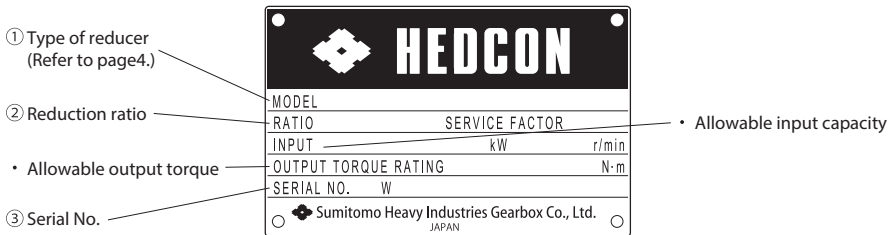

Figure 1 Rating plates

- When making an inquiry, advise us of ① The type of reducer ② Reduction ratio ③ Serial No.

1-2) Lubrication method

Lubrication method for gear portion of standard model is oil bath. Lubrication methods for bearings of standard model are oil bath and splash oil.

- The units are shipped without any oil. Proper amount of oil (Refer to page 13 Table5) should be supplied before start up.

1-3) Type of reducer

Respective codes and HEDCON nomenclature is shown below. Please check to see if the type of gearmotor or reducer you have conforms to what you ordered.

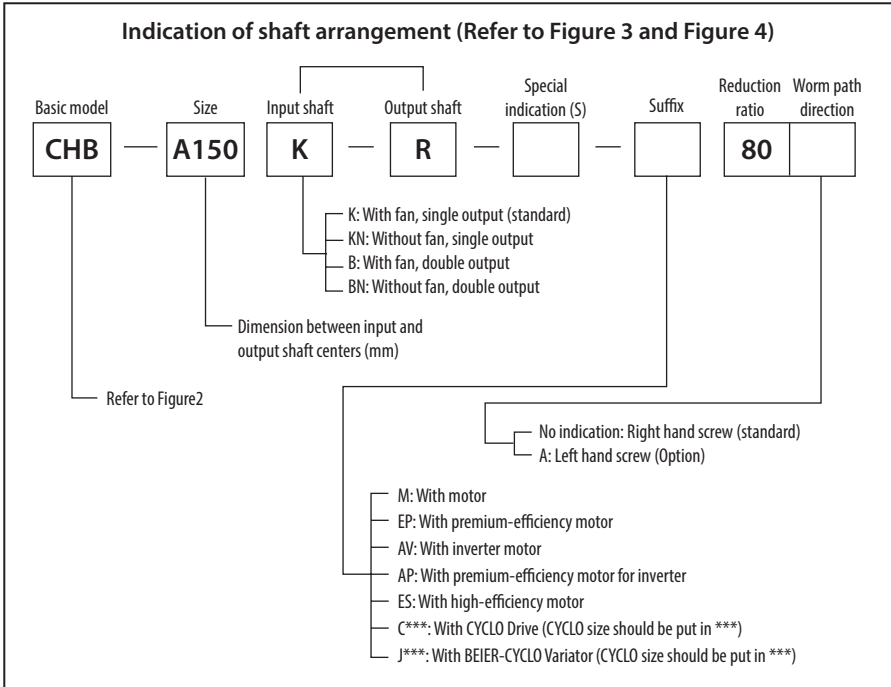

Figure 2 Basic models

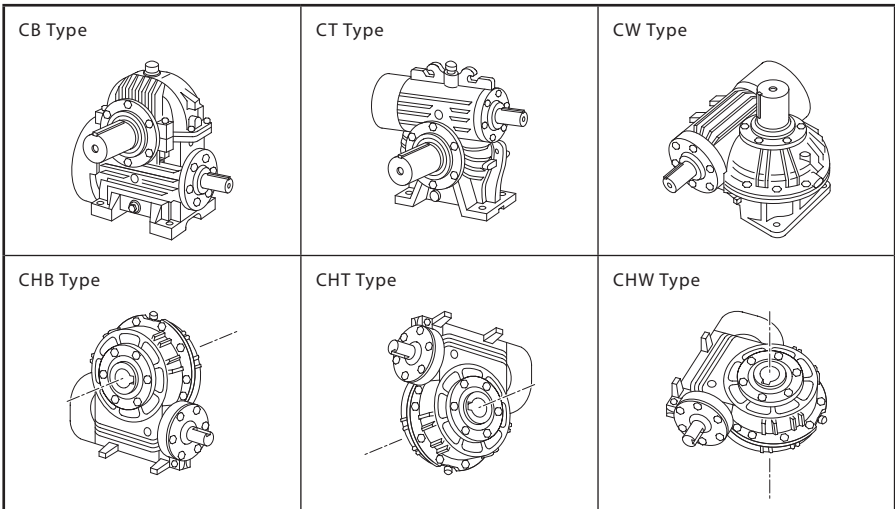
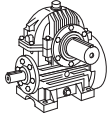
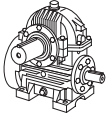
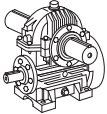
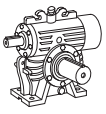
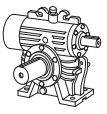
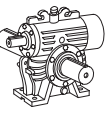
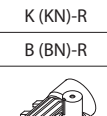
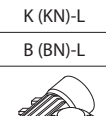
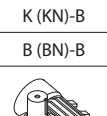
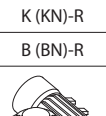
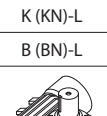
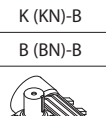
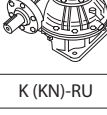
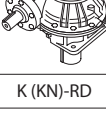

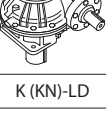
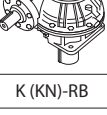
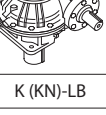

Figure 3 Indication of shaft arrangement (Example of CB, CT, CW Type)

CB Type						
CT Type						
Single input shaft	K (KN)-R	K (KN)-L	K (KN)-B	K (KN)-R	K (KN)-L	K (KN)-B
Double input shaft	B (BN)-R	B (BN)-L	B (BN)-B	B (BN)-R	B (BN)-L	B (BN)-B
CW Type						
Single input shaft	K (KN)-RU	K (KN)-RD	K (KN)-LU	K (KN)-LD	K (KN)-RB	K (KN)-LB
Double input shaft	B (BN)-RU	B (BN)-RD	B (BN)-LU	B (BN)-LD	B (BN)-RB	B (BN)-LB

Shaft arrangement indication R refers to an arrangement where the low speed shaft is positioned on the right hand side, as viewed from the high speed shaft (worm shaft) side, with the legs on the horizontal plane. Similarly, letters L, U, D and B indicate the low speed shaft on the left hand side, upwards, downwards, and on both side, respectively.

Figure 4 Indication of plate installation position (Example of CHB, CHT, CHW Type)

CHB Type						
CHT Type						
Single input shaft	K (KN)-R	K (KN)-L	K (KN)-B	K (KN)-R	K (KN)-L	K (KN)-B
Double input shaft	B (BN)-R	B (BN)-L	B (BN)-B	B (BN)-R	B (BN)-L	B (BN)-B
CHW Type						
Single input shaft	K (KN)-RU	K (KN)-RD	K (KN)-RB	K (KN)-LU	K (KN)-LD	K (KN)-LB
Double input shaft	B (BN)-RU	B (BN)-RD	B (BN)-RB	B (BN)-LU	B (BN)-LD	B (BN)-LB

Plate installation position code R indicates that the plate installed on either CHB, T or W type is positioned on the right hand side, as viewed from the high speed shaft (worm shaft) side. Likewise, code letters L, U, D and B indicate that the plate is positioned on the left hand side, upwards, downwards, and on both sides, respectively.

The figure shows the mounting position of the product with a torque arm as an example. The side where the torque arm is attached is the installation position.

● Indication examples

- CB-A100K-R50

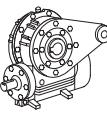
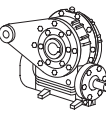
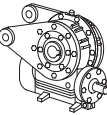
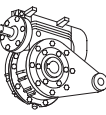
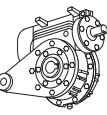
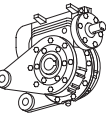
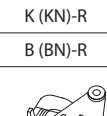
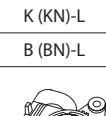
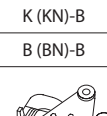
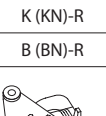
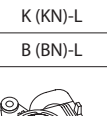
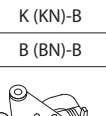
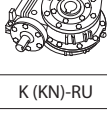
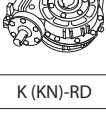
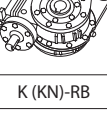
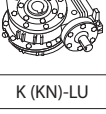
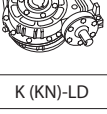
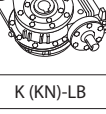
- CW-A100KN-RU-S20

- CHT-A250KN-R10A

2. Storage

When storing reducers for any extended period of time, consider the following important points.

2-1) Storage location

Store the unit in a clean, dry place indoors.

- Avoid storage outdoors or in places with humidity, dust, sudden temperature change, or corrosive gas.

2-2) Storage period

- (1) Storage period should be less than 6 months.
- (2) When the storage period exceeds 6 months, special rust prevention is necessary. Contact us for details.
- (3) Export models need export rust prevention. Contact us for details.

2-3) Use after storage

- (1) Oil seals, oil gauge, oiling plug etc. will deteriorate when exposed to high temperatures and UV rays. Inspect the oil seals before operation. Replace the oil seals with new ones after long term storage if there is any sign of deterioration.
- (2) After starting HEDCON, check that there is no abnormal sound, vibration, or heat built up. If supplied as a broke motor check that the broke operates properly. If any anomaly is observed, contact our nearest agent, distributor, or sales office.

3. Transport



DANGER

- Do not stand directly under a unit suspended by a crane or other lifting mechanism; otherwise, injury or death may result.



CAUTION

- Exercise ample care so as not to drop the reducer. When a hanging bolt or hole is provided, be sure to use it. After mounting a unit on the equipment, do not hoist the entire equipment using the hanging bolt or hole; otherwise, injury or damage to the equipment and/or lifting device may result.
- Before hoisting, check the weight of the reducer by referring to the rating plate, crate, outline drawing, catalog, etc. Never hoist a unit that exceeds the rating of the crate or other mechanisms being used to lift it; otherwise, injury or damage to the equipment and/or lifting device may result.
- When the reducer is lifted, use suitable lifting parts, and confirm that eye bolts and nuts are not loose.

4. Installation



CAUTION

- Do not use the reducer for purposes other than those shown on the rating plate or in the manufacturing specification; otherwise, electric shock, injury, or damage to the equipment may result.
- Do not place any object that will hinder ventilation around the reducer; otherwise, the cooling effect is reduced, possibly leading to fire or burns due to excessive heat build up.
- Do not step on or hang from the reducer; otherwise injury may result.
- Do not touch the shaft end of the reducer, inside keyways, or the edge of the motor cooling fan with bare hands; otherwise, injury may result.
- When the unit is used in food processing applications vulnerable to oil contamination, install an oil pan or other such device to cope with oil leakage due to failure or limited service life; otherwise, oil leakage may damage products.

- Install the unit on a sufficiently rigid base by minimum strength class 10.9 foundation bolts (JIS B 1051).
- Avoid such installation as the housing is deformed.
- Thought the high speed shaft. Center and motor center on a base plate are properly aligned before shipment, along them at the installation. Because the shaft center is not in alignment with the motor center by the transfer or the irregular surfaces of concrete base.
- Proper amount of oil should be supplied after the installation. (The oil should not be supplied before the installation.)
- High speed shaft, slow speed shaft, key and machine surface for installation are painted with rust preventive oil. Wash them before the installation. Do not use special solvent and sand paper for the washing.

5. Coupling with other machines

CAUTION

- Confirm the direction of rotation before coupling the unit with the driven machine. Difference in the direction of rotation may cause injury or damage to the equipment.
- When operating the reducer alone (uncoupled), remove the key that is temporarily attached to the output shaft; otherwise, injury may result.
- Cover the rotating parts; otherwise, injury may result.
- When coupling the reducer with a load, check that the centering, the belt tension and parallelism of the pulleys are within the specified limits. When the unit is directly coupled with another machine, check that the direct coupling accuracy is within the specified limits. When a belt is used for coupling the unit with another machine, check the belt tension. Correctly tighten bolts on the pulley and coupling before operation; otherwise, injury may result because of misalignment.

5-1) Confirmation of direction of rotation

Figure 5 Rotational direction of input shaft and output shaft

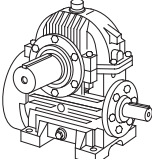
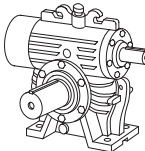
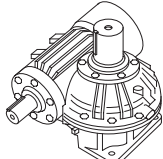
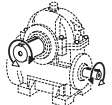
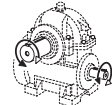
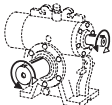
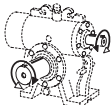
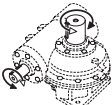
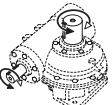
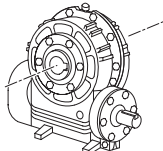
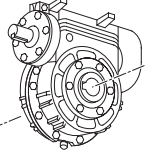
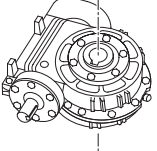
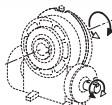
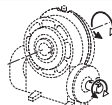
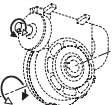
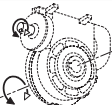
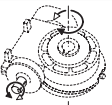
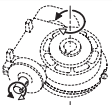
CB Type		CT Type		CW Type	
					
Worm path direction		Worm path direction		Worm path direction	
Right hand screw (standard)	Left hand screw (option)	Right hand screw (standard)	Left hand screw (option)	Right hand screw (standard)	Left hand screw (option)
					
CHB Type		CHT Type		CHW Type	
					
Worm path direction		Worm path direction		Worm path direction	
Right hand screw (standard)	Left hand screw (option)	Right hand screw (standard)	Left hand screw (option)	Right hand screw (standard)	Left hand screw (option)
					

5-2) Installation of coupling

- When installing a coupling, do not impact or apply excessive thrust load to the shaft; otherwise, the bearing may be damaged.
- Installation by thermal shrinking is recommended.

(1) When coupling is used

The accuracy of the dimensions (A, B, and X) shown in Figure 6 should be within the tolerance shown in Table 1.

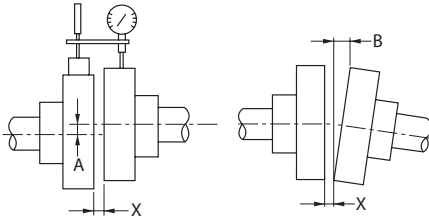

Figure 6

Table 1 Centering accuracy of flexible coupling

Tolerance for A dimension	0.1mm or maker's specification
Tolerance for B dimension	0.1mm or maker's specification
X dimension	Maker's specification

(2) When chain sprocket and gear are used

- The chain tension angle should be perpendicular to the shaft.
- Refer to the chain catalog for the chain tension magnitude.
- Select sprockets and gears whose pitch diameter are three times the shaft diameter or greater.
- Install sprocket and gears so that their point of load application will be closer to the gear motor or reducer side with respect to the length of the shaft. (Figure 7)

(3) When v belt is used

- Excessive v belt tension will damage the shaft and bearing. Refer to the v belt catalog for proper tension magnitude.
- The parallelism and eccentricity (β) between two pulleys should be within 20'. (Figure 8)
- Use a matched set with the same circumferential length when more than one belt is to be installed.

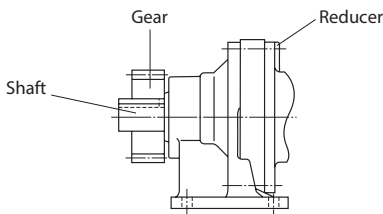

Figure 7

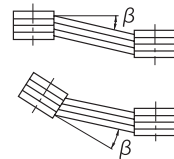

Figure 8

6. Operation



DANGER

- Do not approach or touch rotating parts (output shaft, etc.) during operation; otherwise, loose clothing caught in these rotating parts may result in serious injury or death.



CAUTION

- Do not put fingers or foreign objects into the opening of the gearmotor or reducer; otherwise electric shock, injury, fire, or damage to the equipment may result.
- The reducer will become very hot during operation. Do not touch or come in contact with the unit; otherwise, burns may result.
- Do not loosen the oil filler plug during operation; otherwise, hot splashing lubricant may cause burns.
- If an anomaly occurs during operation, stop operation immediately; otherwise, electric shock, injury, or fire may result.
- Do not operate the unit in excess of the rating; otherwise, injury or damage to the equipment may result.

- The units are shipped without any oil. Proper amount of oil (Refer to page 13 Table 5) should be supplied before start up.

After the unit is installed, supplied with oil and properly wired, check the following before starting operation.

- (1) Is the coupling with the driven machine correct?
- (2) Are foundation bolts tightened firmly?
- (3) Is the direction of rotation as required.
- (4) Does the oil level reach above the center of the oil level gauge when the unit is at rest?

After confirming the above items, a break in operation is conducted in accordance with procedures which are showed on page 11.

Break in operation

In spite of the precision machining, worm gear reducers do not normally exhibit their prescribed performance unless adequately broken in, due to the intrinsic features of gear engagement.

Accordingly, to assure the best conditions under use. We recommend that a break in operation is conducted in accordance with the following procedures. Prior to the commencement of normal operations.

- (1) Gradually increase the load in according with the following sequence.

Table 2 Break in sequence

(Unit: h)

Break in sequence	Size	63 - 250 A100 - A250	280 - 400
(1) No load start up		0.5	0.5
(2) Operation at 25% of full load		2 to 3	6 to 9
(3) Operation at 50% of full load		2	6
(4) Operation at 75% of full load		2	6
(5) Operation at full load		2	6

- (2) Particular caution must be given to the oil temperature during the break in operations. Should the oil temperature rise to above 100°C (Input shaft bearing housing temperatures rises about 90°C) during the break in operation, the load should be reduced to the preceding load step which is showed on Table2, at which the break in operation should be repeated.

If the temperature is consistently about 100°C, the cause may be any of the following, which should be thoroughly checked.

- ① The ambient temperature is higher than the specified conditions.
 - ② Over load
 - ③ Inappropriate viscosity of selected lubricant.
- (3) Even though break in operation of the unit has been done, it is recommended that no load operation is conducted for a while.
 - (4) Any abnormal conditions in the reducer can be grasped during the break in operations.

If abnormal noise and vibration are noted, the following should be thoroughly checked.

- ① The housing is deformed because the installation surface is irregular.
- ② Resonance is occurring due to the lack of rigidity of the installation base.
- ③ The shaft center is not properly aligned with the mating machine.
- ④ The vibration of the mating machine is transmitted to the reducer.

Nevertheless any abnormal conditions can not be improved, stop operation and contact the nearest agent, dealer or service office.

7. Daily inspection and maintenance

DANGER

- Do not approach or touch any rotating parts (output shaft, etc.) during maintenance or inspection of the unit; otherwise, loose clothing caught in these rotating parts may result in injury or death.
- Do not remove an inspection cover during operation; otherwise, splashing hot lubricant may cause burn.

CAUTION

- Do not put fingers or foreign objects into the opening of the reducer; otherwise, electric shock, injury, fire, or damage to the equipment may result.
- The reducer will become very hot during operation. Do not touch the unit with bare hands; otherwise, burns may result.
- Identify and provide appropriate corrective action in a timely fashion and according to this maintenance manual if any abnormal operating characteristics are observed. Do not operate the unit until corrective action has been taken.
- Change lubricant according to the maintenance manual. Be sure to use lubricant recommended by us.
- Do not change lubricant during operation or right after operation is stopped; otherwise, burns may result.
- Do not use damaged reducers; otherwise, injury, fire, or damage to the equipment may result.
- We can not assume any responsibility for damage or injury as a result of an unauthorized modification by a customer.
- Dispose of the reducer, lubricant as general industrial waste.

- Although it will depend on operation conditions, maintenance with disassembly after approximately 20,000 hours or 3 to 5 years will increase lifetime.
- Contact the nearest authorized maintenance shop regarding maintenance with disassembly.

7-1) Daily inspection

To ensure proper and continued optimum operation, use table3 to perform daily inspections.

Table 3 Daily inspection

Inspection item	Details of inspection
Noise	Is there abnormal sound? Is there sudden change in sound?
Vibration	Is the vibration abnormally large? Does vibration Change suddenly?
Surface temperature	Is the surface temperature abnormally high? Does the surface temperature rise suddenly?
Oil level	Does the oil level reach the upper of the oil gauge center when the unit is at rest?
Foundation bolt	Are foundation bolts loose?
Chain and v belt	Are chain and v belt loose?
Oil	Does oil glitter by metal chips in the oil?
Oil leakage	Does oil leak from gear section?

When some anomaly is found during the daily inspection, take corrective measures according to section 9. Troubleshooting (page 15) If the anomaly cannot be eliminated, contact our nearest agent, distributor, or sales office.

7-2) Lubrication method

Lubrication method for gear portion of standard model is oil bath. Lubrication methods for bearings of standard model are oil bath and splase oil.

7-3) Supply and change of lubrication oil

(1) Lubrication oil change interval

Table 4 Lubrication oil change interval

	Change interval	
Oil supply	Right after purchase	
Oil change	1st change	After 500hours of operation.
	Subsequent changes	After every 5000hours of operation or once every year

(2) Specified Lubricating Oil

Table 5 Specified lubricating oil (Polygraycol-based synthetic oil)

Input speed (r/min)	Oil manufacturer and lubricating oil (Polygraycol-based synthetic oil)		
	Shell	Klüber	Mobil
500 to 1800	Shell Omala S4 WE 220	Syntheso HT 220	Mobil Glygoyle 220
Lower than 500	Shell Omala S4 WE 460	Syntheso HT 460	Mobil Glygoyle 460

- Be sure to use the specified lubricating oil of polygraycol-based synthetic oil. However, when “mineral oil” is specified as a lubricant in the manufacturing specifications, select the lubricant oil from Table 6. If you are unsure of the contents of the manufacturing specifications, contact our nearest distributor, dealer, or sales office.

Table 6 Reference oil (mineral oil)

Input speed (r/min)	Oil manufacturer and lubricating oil (mineral oil)										
	BP	Castrol			Chevron	TEXACO	Mobil		Shell		Total
500 to 1800	Energol GR-XP 320	Alpha SP 320	Optigear BM 320	Tribol 1100/320	Gear Compounds EP 320	Meropa WM 320	Spartan EP 320	Mobilgear 600XP 320	Shell Omala S2 G 320	Shell Omala S2 GX 320	CARTER EP 320
Lower than 500	Energol GR-XP 460	Alpha SP 460	Optigear BM 460	Tribol 1100/460	Gear Compounds EP 460	Meropa WM 460	Spartan EP 460	Mobilgear 600XP 460	Shell Omala S2 G 460	Shell Omala S2 GX 460	CARTER EP 460

- Never mix synthetic oil and mineral oil.

(3) Oil quantity

- Specification sheet show approx quantity of oil.
- In order to constantly check the oil level, a window type oil gauge has been mounted at easily visible position on the housing.
- Supply oil unto a level slightly above the center of the oil level gauge, while the reducer is stopped. Upon completion of the oil filling, conduct a no load operation until the lubrication has thoroughly spread throughout the gears and bearings, after which the reducer should be stopped and the oil level should be checked for adequacy.
- If the oil level is near the center of the oil level gauge, this should be adequate. During operations, the oil level may vary considerably, which must be carefully observed, as the oil quantity may be insufficient, even though the oil gauge may show a level within the prescribed level.

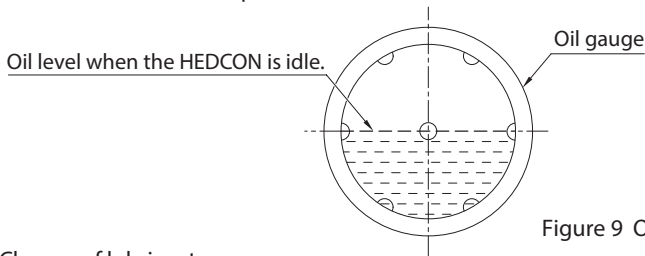

Figure 9 Oil level gauge

(4) Change of lubricant

(i) Periodical change

- ① Discharge the used oil.
- ② After discharging, fill with new oil.

In the case of oil pollution, flushing should be conducted in accordance with the following (ii) procedures.

(ii) Change of lubricant at oil pollution.

- ① Discharge the used oil.
- ② Fill with low viscosity flushing oil.
- ③ No load operation for several minutes.
- ④ Discharge the flushing oil.
- ⑤ Fill with minimum quantity of designated oil.
- ⑥ No load operation for several minutes.
- ⑦ After discharging the fore going oil, fill with new oil.

7-4) Grease Lubricated models

(1) Grease replenishment intervals

Size	63-A175	A200-400
Replenishment quantity	20g	50g
Replenishment interval	Every 1000 hours, or every 6 months, whichever comes first.	

- Grease lubrication models are filled with grease when they are shipped.
- Since grease fittings and discharging valves are attached, carefully check the number and position of them when replenishing grease.
- For the position of the grease fittings and discharging valves, see the outline drawing of the manufacturing specifications.

(2) Lubricating grease

Shell Alvania EP Grease 2 (Oil manufacturer: Shell)

7-5) Inspection and replacement of oil seals

Wear in the seals may cause oil leakage, for which reason they should be regularly inspected and replaced adequately in advance.

Different seals from existence should be avoided, since they soon lead to oil leakage.

Consult our service office to replace the oil seal.

8. Disassembly and assembly

- Do not disassemble the unit.
- To assure that this reducer can exhibit its full functional potential, the gear engagements and bearing clearances have been adjusted with high precision.
- Consult us whenever disassembly becomes unavoidable.

9. Troubleshooting

- If an anomaly occurs in the reducer, refer to Table 7 below and take appropriate measures as soon as possible.

Table 7 Troubleshooting

Problem	Possible cause	Correction
Excessive temperature rise	Overload	Decrease the load.
	Oil pollution or unsuitable oil are used.	Discharge the used oil, conduct flushing and then fill with new oil.
	Oil quantity is unsuitable. Insufficient or too much.	Oil quantity should be suitable.
	Bearing clearance is too narrow.	Return the unit to factory for servicing.
Oil leakage	Damaged oil seal	Replace the oil seal with a new one.
	Damaged oil gauge	Replace the oil gauge with a new one.
	Damaged packing	Replace the packing with a new one.
	Loose bolts & plugs	Tighten bolts correctly.
Abnormal sound Abnormal vibration	Damaged bearing	Return the unit to factory for servicing.
	Gear engagement is unsuitable.	
	Bearing clearance is too narrow.	
	Damaged gear	Add oil.
	Oil quantity is insufficient.	
Entry of foreign matter into oil.	Replace the oil.	
Output shaft does not rotate	There is no tooth due to wear.	Return the unit to factory for servicing.
	Breakage of high speed shaft or slow speed shaft.	
	Breakage of key between worm wheel and wheel shaft.	
	In the case of gear motor, breakage of key between motor shaft and high speed shaft or motor shaft itself.	
Input and output do not rotate	Entry of foreign matter into gear engagement.	Return the unit to factory for servicing.
	Bearing is burned or damaged.	
	Teeth surface is burned.	

10. Construction drawing

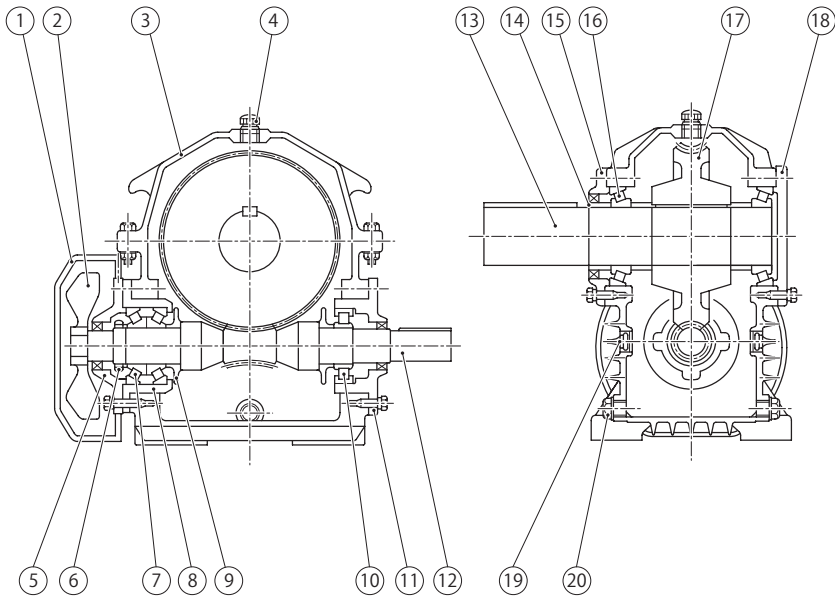

Figure 10

- This is a model construction based on CB-A200 type.
- This only shows an example of the basic structures and may differ according to type or size.

Table 8

No.	Parts name	No.	Parts name	No.	Parts name
1	Fan cover	8	Bearing cage (1)	15	Output shaft cover (1)
2	Fan	9	Oil fringer plate	16	Taper roller bearing
3	Housing	10	Cylindrical roller bearing	17	Worm wheel
4	Oil filler	11	Bearing cage (2)	18	Output shaft cover (2)
5	Worm shaft cover	12	Worm shaft	19	Oil gauge
6	Nut for bearing	13	Output shaft	20	Oil drain plug
7	Taper roller bearing	14	Collar		

11. Warranty

The scope of warranty of our delivered products is limited only to what we manufactured.
Warranty (period and description)

Warranty period	The warranty period applies only to new products and represents 18 months after the shipment or 12 months after the actual operation, whichever is shorter.
Description	<p>If the product failed within the warranty period, during which despite a proper mounting, connection and maintenance & administration are followed according to the maintenance manual, and the product is properly run based on the specification on the catalog or under conditions agreed separately, we will repair or provide an alternative product at our discretion for free of charge, except the exclusions below.</p> <p>However, as far as the product is connected with customers' other devices, we will not indemnify those expenses on dismounting from/mounting on the devices, etc. and other associated construction expenses, transportation expenses and opportunity loss and operation loss the customers suffered from, and other indirect damages.</p>
Exclusion from the warranty	<p>The following items will be excluded from the warranty:</p> <ol style="list-style-type: none"> 1. A breakdown resulting from defects in the installation of the product and coupling with other devices, etc. 2. A breakdown resulting from insufficient maintenance & administration and improper handling of the product, including a case that the product is not stored according to our defined storage manual. 3. A breakdown resulting from operation which does not fall within our specification and other operation conditions and use status we hardly can know or a failure caused by the use of lubricant which we do not recommend. 4. A breakdown resulting from defects, special specification, etc of device prepared and connected by customer. 5. A breakdown resulting from disassembly, parts replacement, and modification conducted by the customer. 6. A breakdown resulting from defects in parts supplied or specified by customers. 7. A breakdown caused by inevitable force including earthquake, fire, flood disaster, salt damage, gas damage, and lightning strike, etc. 8. Natural wear and tear, abrasion, and deterioration of such relevant consumable parts as a bearing and oil seal, etc. under normal usage. 9. A breakdown caused for reasons not attributable to each of the above item.

Worldwide Locations

U.S.A

Sumitomo Machinery Corporation of America (SMA)
4200 Holland Blvd. Chesapeake, VA 23323, U.S.A.
TEL (1)905-485-3355 FAX (1)757-485-7490

Canada

SM Cyclo of Canada, Ltd. (SMC)
1453 Cornwall Road, Oakville, Canada ON L6J 7T5
TEL (1)905-469-1050 FAX (1)905-469-1055

Mexico

SM Cyclo de México, S.A. de C.V. (SMME)
Fresnos #201, Pocket Park Oriente, 67258 Juárez, N.L.
México
TEL (52)81-8144-5130

Brazil

Sumitomo Industrias Pesadas do Brasil Ltda. (SHIB)
Rodovia do Acucar (SP-075) Km 26
Itu, Sao Paulo, Brasil
TEL (55)11-4886-1000 FAX (55)11-4886-1000

Chile

SM-Cyclo de Chile Ltda. (SMCH)
Camino Lo Echevers 550, Bodegas 5 y 6,
Quilicura, Región Metropolitana, Chile
TEL (56)2-892-7000 FAX (56)2-892-7001

Argentina

SM-Cyclo de Argentina S.A. (SMAR)
Ing Delpini 2230, B161 5KGB Grand Bourg,
Malvinas Argentinas, Buenos Aires, Argentina
TEL (54)3327-45-4095 FAX (54)3327-45-4099

Guatemala

SM Cyclo de Guatemala Ensambladora, Ltda. (SMGT)
Parque Industrial Unisur, 0 Calle B 19-50 Zona 3,
Bodega D-1 Delta Bárcenas en Villa Nueva, Guatemala
TEL (502)6648-0500 FAX (502)6631-9171

Colombia

SM Cyclo Colombia, S.A.S. (SMCO)
Parque Industrial Celta, Km 7.0 Autopista Medellín,
Costado Occidental, Funza, Cundinamarca, Colombia
TEL (57)1-300-0673

Peru

SM Cyclo de Perú, S.A.C (SMPE)
Jr. Monte Rosa 255, Oficina 702, Lima,
Santiago de Surco, Perú
TEL (51)1-713-0342 FAX (51)1-715-0223

Germany

Sumitomo (SHI) Cyclo Drive Germany GmbH (SCG)
Cyclostraße 92, 85229 Markt Indersdorf, Germany
TEL (49)8136-66-0 FAX (49)8136-5771

Austria

Sumitomo (SHI) Cyclo Drive Germany GmbH (SCG)
SCG Branch Austria Office
Gruentalerstraße 30A, 4020 Linz, Austria
TEL (43)732-330958 FAX (43)732-331978

Belgium

Hansen Industrial Transmissions NV (HIT)
Leonardo da Vinciiaan 1, Edegem, Belgium
TEL (32)34-50-12-11 FAX (32)34-50-12-20

France

SM-Cyclo France SAS (SMFR)
8 Avenue Christian Doppler, 77700 Serris, France
TEL (33)9448-05389 FAX (33)164171718

Italy

SM-Cyclo Italy Srl (SMIT)
Via dell'Artigianato 23, 20010 Cornaredo (MI), Italy
TEL (39)293-481101 FAX (39)293-481103

Spain

SM-Cyclo Iberia, S.L.U. (SMIB)
C/Gran Via Nº 63 Bis, Planta 1, Departamento 1B
48011 Bilbao-Vizcaya, Spain
TEL (34)9448-05389 FAX (34)9448-01550

United Kingdom

SM-Cyclo UK Ltd. (SMUK)
Unit 29, Bergen Way, Sutton Fields Industrial Estate,
Kingston upon Hull, HU7 0YQ, East Yorkshire,
United Kingdom
TEL (44)1482-790340 FAX (44)1482-790321

Turkey

SM Cyclo Turkey Güç Aktarım Sis. Tic. Ltd. Sti. (SMTR)
Barbaros Mh. Çiğdem Sk. Ağaoğlu, Office Mrk. No:1 Kat:4 D.18
Atasehir, Istanbul, Turkey
TEL (90)216-250-6069 FAX (90)216-250-5556

India

Sumi-Cyclo Drive India Private Limited (SDI)
Gat No. 186, Raisonni Industrial Park, Alandi Markal Road,
Fulgaon-Pune, Maharashtra, India
TEL (91)96-0774-5353

China

Sumitomo (SHI) Cyclo Drive Shanghai, Ltd. (SCS)
11F, SMEG Plaza, No. 1386 Hongqiao Road,
Changning District, Shanghai, China 200336
TEL (86)21-3462-7877 FAX (86)21-3462-7922

Hong Kong

SM-Cyclo of Hong Kong Co., Ltd. (SMHK)
Room 19, 28th Floor, Metropole Square, No.2 On
Yiu Street, Shatin, New Territories, Hong Kong
TEL (852)2460-1881 FAX (852)2460-1882

Korea

Sumitomo (SHI) Cyclo Drive Korea, Ltd. (SCK)
Royal Bldg Room #913, 19, Saemunan-ro 5-gil,
Jongno-gu, Seoul, 03173, Korea
TEL (82)-2-730-0151 FAX (82)-2-730-0156

Taiwan

Tatung SM-Cyclo Co., Ltd. (TSC)
22 Chungshan N. Road 3rd, Sec. Taipei, Taiwan 104,
R.O.C.
TEL (886)2-2595-7275 FAX (886)2-2595-5594

Singapore

Sumitomo (SHI) Cyclo Drive Asia Pacific Pte. Ltd. (SCA)
15 Kwong Min Road, Singapore 628718
TEL (65)6591-7800 FAX (65)6863-4238

Philippines

Sumitomo (SHI) Cyclo Drive Asia Pacific Pte. Ltd. Philippines Branch Office (SMPH)
C4 & C5 Buildings Granville Industrial Complex, Carmona,
Cavite 4116, Philippines
TEL (63)2-584-4921 FAX (63)2-584-4922

Vietnam

SM-Cyclo (Vietnam) Co., Ltd. (SMVN)
Factory 2B, Lot K1-2-5, Road No. 2-3-5A,
Le Minh Xuan Industrial Park, Binh Chanh Dist.,
HCMC, Vietnam
TEL (84)8-3766-3709 FAX (84)8-3766-3710

Malaysia

SM-Cyclo (Malaysia) Sdn. Bhd. (SMMA)
No.7C, Jalan Anggerik Mokara 31/56, Kota Kemuning,
Seksyen 31, 40460 Shah Alam, Selangor Darul Ehsan,
Malaysia
TEL (60)3-5121-0455 FAX (60)3-5121-0578

Indonesia

PT. SM-Cyclo Indonesia (SMID)
Jalan Sungkai Blok F 25 No. 09 K, Delta Silicon III,
Lippo Cikarang, Bekasi 17530, Indonesia
TEL (62)21-2961-2100 FAX (62)21-2961-2211

Thailand

SM-Cyclo (Thailand) Co., Ltd. (SMTH)
195 Empire Tower, Unit 2103-4, 21st Floor, South
Sathorn Road, Yannawa, Sathorn, Bangkok 10120,
Thailand
TEL (66)2670-0998 FAX (66)2670-0999

Australia

Sumitomo (SHI) Hansen Australia Pty. Ltd. (SHAU)
181 Power St, Glendenning, NSW 2761, Australia
TEL (61)2-9208-3000 FAX (61)2-9208-3050

Japan

Sumitomo Heavy Industries, Ltd. (SHI)
ThinkPark Tower, 1-1 Osaki 2-chome, Shinagawa-ku,
Tokyo 141-6025, Japan
TEL (81)3-6737-2511 FAX (81)3-6866-5160

Specifications, dimensions, and other items are subject to change without prior notice.

 Sumitomo Heavy Industries, Ltd.

Power Transmission & Controls Group

Headquarter ThinkPark Tower, 1-1 Osaki 2-chome, Shinagawa-ku, Tokyo 141-6025, Japan

No.WM0101E-6.7

EA15 Printed 2023.12