



Sumitomo Drive Technologies

THE RIGOROUS APPLICATION OF FMEA TO

WASTEWATER AERATOR DRIVES

TOMOKI TANAKA
CHAIRMAN TECHNICIAN

DAN ROSSELJONG
GEARBOX PRODUCTION MANAGER

US.SUMITOMODRIVE.COM

IMECE2009-10498

THE RIGOROUS APPLICATION OF FMEA TO A WASTEWATER TREATMENT PLANT AERATOR DRIVE: UNDERSTANDING REQUIREMENTS, CONDITIONS, LIMITATIONS AND SUCCESS FACTORS

Tomoki Tanaka

Paramax Product Engineer
Sumitomo Machinery Corporation of America
Chesapeake, Virginia, 23323, United States
tmk_tanaka@shi.co.jp

Daniel J. Rosseljong

Chief Products Engineer
Sumitomo Machinery Corporation of America
Chesapeake, Virginia, 23323, United States
drosseljong@suminet.com

ABSTRACT

Any supplied gearbox performing below a user's clearly defined expectations can be viewed as a failure. This case study involves consistent lubricant leakage starting almost immediately after installation. Through various field inspections, modifications and a factory rebuild, the problem was not resolved to the owner's satisfaction until replaced by (2) new units. This paper documents the factual elements of an engineering evaluation of a gearbox removed from an aerator drive at a wastewater treatment facility, using FMEA [Failure Modes and Effects Analysis] over FTA [Fault Tree Analysis]. The gearbox supplier chose FMEA because it considers the importance of the gearbox components, weighting them to the application, where FTA is often a pure top-down analytical engineering approach without consideration for external factors. The gearbox supplier performed a detailed disassembly of the gearbox under controlled conditions and inspected each gearbox component to identify any faults in material or designs focusing on those that affect the user. The goal of this analysis is to provide a technical understanding of the cause(s) of failure, its consequences, and a means to correct any problems with the gearbox, real or perceived.

INTRODUCTION

Aerators are essential in the efficient treatment of wastewater. The basic function of an aerator is to increase oxygen transfer so that beneficial bacteria can break down biological pollutants in the water. The increasing world populations and demands for responsible ecological actions to safeguard our increasing water supply requirements can only emphasize the growing importance of aerators as they return wastewater to nature without any harmful chemicals or biological elements. Aerators can account for a quarter of wastewater plant total energy costs.[1] The gearbox supplier's

experience indicates aerators account for the largest single application source of wastewater plant total energy costs. There are many types of aerator drives. This paper refers to a vertical, impeller driven oxidation ditch, as shown in Figure 1, where the gearbox supports the weight and thrust load of the impeller. In these types of applications, the selection of the gearbox is critical to withstand the aerator impeller thrust and radial loads – as the long impeller shaft creates a large bending moment on the gearbox low speed shaft. The low speed bearings need to be adequately sized to accommodate these loads to provide the required long term bearing life. This paper is valuable for wastewater treatment plant personnel, aerator suppliers, and power transmission suppliers wanting to supply new or replacement equipment and maintaining equipment to provide long-term, trouble free operation of the mechanical components of aerator drive equipment. This example might be useful for students to understand the importance of 'real world' conditions as they apply to the design, selection and supply of mechanical equipment.

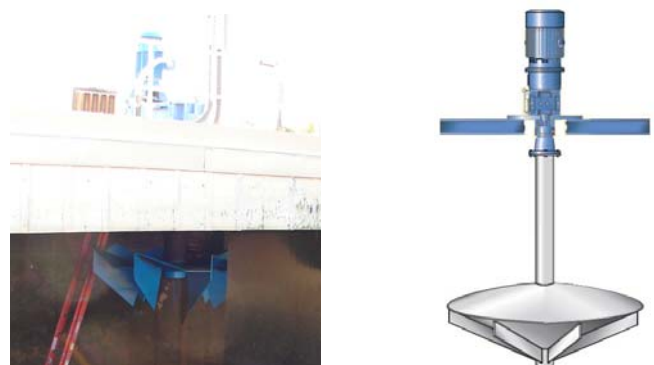

Figure 1. Reducer Supported Oxidation Ditch Aerator Drive

BACKGROUND

Wastewater needs to be treated so that it is returned as clean as when it was originally taken from the water supply. Mineral or synthetic based lubricants harm the beneficial bacteria, which is used in the aeration process. Seal leakage on the vertical down low speed shaft (LSS) is of paramount concern to wastewater treatment personnel. The original specification for the supply of mechanical components identifies this need to prevent lubricant leakage into the water supply. Typically a 'drywell' design –Figure 2, is supplied isolating the LSS from the gearbox oil sump. The lower bearing (shaft projection side) is then required to be grease lubricated.

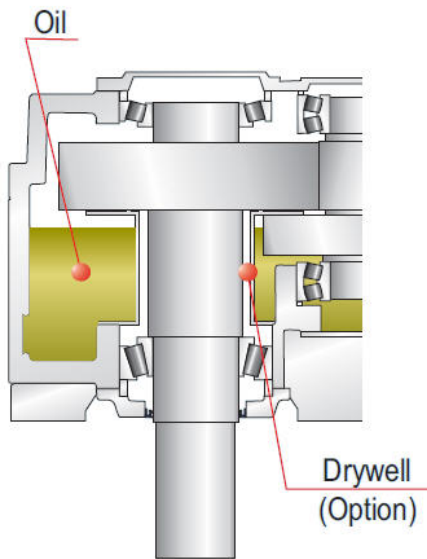

Figure 2. Drywell Schematic

In the gearbox supplier's particular instance, 2 identically specified and sized gearboxes were installed in a Wisconsin municipal wastewater treatment facility.

Motor: 56kW [75Hp], 1785rpm (900rpm constant torque)
Axial Load: $F_a = 13.8\text{kN}$ upward [3,103lb_f]
Radial Load: $F_r = 1.83\text{kN}$ at 1830mm from gearbox mounting surface [900lb_f at 6ft]

The only differences between the 2 installations are application related: the direction of rotation. Aerator 1 (Left-Figure 3) is clockwise and Aerator 2 (Right-Figure 3) is counterclockwise, when looking down through the gearbox. The gearbox is of a standard design, modified for vertical aerator operation. Modifications include: immersion oil heater, LSS drywell construction, shaft driven pump (to lubricate the upper bearings) and flow switch (for low flow indication of bearing lubrication).



Figure 3. Aerator 1 (Original - Left), Aerator 2 (Replacement - Right)

The original units were supplied in 2002 to the aerator Original Equipment Manufacturer (OEM) for installation. Operation of the equipment began in 2003. Within months of continuous operation the user complained of intermittent lubricant leakage from the low speed seals on both aerator drives. On two separate occasions during 2003 and 2004, site visits were performed by the gearbox supplier to inspect, clean, and assess the leaking problem. During the visits, gearbox supplier personnel cleaned the grease leakage from the low speed seal and removed and cleaned the grease relief lines. There was some concern during the original installation, as the customer commented that they were re-greasing as they felt was necessary to replace the leaking lubricant. The supplied requirement was every 1,500 hours (two months for 24/7 operation). The user was advised to reduce the re-grease interval to 6 months. The gearbox supplier assumed the maintenance personnel was applying too much grease to the lower bearing.

In Jan 2005, the gearbox supplier determined that the best course of action would be to remove the units from service and return them to the assembly plant for warranty inspection and repair, even though the gearboxes had no other noticeable problems or concerns during operation. The ensuing factory inspection determined that the grease was being contaminated by oil ingress into the drywell. Oil path was through the gear keyway. The solution was to prevent oil ingress past the key with a spacer that was significantly wider than standard, effectively blocking the oil path to the keyseat. See Annex E for factory inspection reports.

Aerator 1 gearbox was returned to service in October of 2005 and within 1 year of continuous operation, sporadic LSS seal leakage was observed by on-site personnel.

In May 2007, factory engineers returned to the site for inspection and application observation. All operating temperatures were found to be well within acceptable norms. Excessive low speed shaft deflection was observed. Dial indicator readouts conducted over a 4-hour period indicated a maximum runout of 5mm, taken at the top of the low speed coupling on Aerator 1. The rust proof coating and the surface of the low speed coupling are assumed to account for approximately 0.1-0.5mm, resulting in what was thought to be 4.5-4.9mm runout. Aerator 2 did not show any abnormal leakage at the low speed shaft and operation noise and vibrations were within norms. No shaft runout was measured on Aerator 2. Discussions with seal manufacturers recommend a maximum 0.5mm runout [2] for standard nitrile rubber seal engagement.

The OEM and end-user were advised to reduce the internal grease chamber pressure by installing an expansion chamber. It was recommended the user also consider a drop-bearing design to accommodate excessive shaft loads. This design replaces the standard low speed shaft assembly with a longer shaft having a significantly longer bearing span, (Figure 4). It was assumed that the longer bearing span would reduce the shaft deflection and provide excessive service factor to the bearing life, accommodating any aerator loads above the calculated thrust and radial loads.

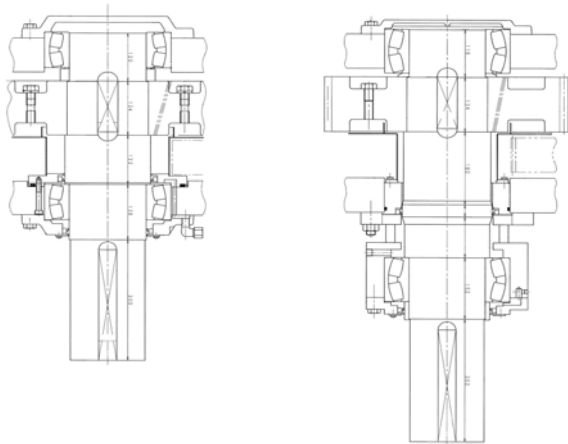

Figure 4. Standard (Left) and Drop Bearing Designs

At this point the seal leakage had reached its climax. The end user and OEM had perceived the seal leakage to be a unit failure and requested that the units be replaced.

The gearbox supplier checked the project application information again and reconfirmed that the gearbox was adequately sized for the aerating application – based on the input requirements of speed, Hp and aerator radial and axial forces. Their review of the application input requirements and

industry experience led them to believe that the potential cause of failure was related to the application.

The calculated service factor (SF) on Bending Fatigue was 5.8 for the worst-case direction of rotation (equating to Aerator 2 – which did not maintain the grease leakage problem after the 1st rebuild). The gearbox supplier suspected that the aerator had somehow exceeded its calculated design parameters. On agreement between the OEM and end-user, they agreed to supply two new replacement gearboxes for both aerators. Two units were supplied on request and management agreed that both units should remain identical.

The same size gearcase and gearing were supplied, as the Hp requirements were not in question. The new unit aerator modifications did include a heavy-duty drop bearing design.

In August 2008, Aerator 2 was replaced with the new heavy-duty drop bearing design. A condition of the replacement included the Aerator OEM to check the runout and balance of the aerator impeller. The impeller was removed from the tank and checked on-site and found to be well balanced and within design dimensional tolerances. A visual inspection of the tank showed a build-up of sediment. No other abnormalities were found. The original unit was returned to the assembly plant for failure analysis.

In October 2008, Aerator 1 was replaced with the new heavy-duty drop bearing design. A visual inspection of the tank showed a build up of sediment. Refer to Annex D Figure 6-7 for Photos. The sediment was found to be different than in Aerator 2 tank. This sediment appeared to be mixed with a fibrous textured debris in approximately 20% of the sediment. Again, the impeller was checked for runout and balance. The impeller inspection revealed an imbalance and fractured blade tips. Annex D, Figure 8. A counter weight was added to one of the blades to bring the impeller into balance. Annex D, Figure 9. During the same trip, the gearbox supplier inspected Aerator 2 unit, which had been operating continuously for 2.5 months. The unit temperatures and operation were all found to be within normal parameters. No seal leakage was observed. Aerator 1 unit was returned to the assembly plant for failure analysis.

FMEA ANALYSIS

The reliability technique, Failure Modes and Effect Analysis can often help identify potential design weaknesses for both product and application. FMEA provides a detailed way of examining the various modes of system failure, the likely effects of those failures, and the severity of the effects. [3,4] This technique was chosen over alternative methods because we felt it was important to consider the application and manufacturing and assembly processes. Fault Tree Analysis (FTA) is a pure top-down analytical approach where application is not usually considered. Equation (1) was used to

determine the Risk Priority Number (RPN) as detailed in Table 1 [5] of the Annex B.

$$RPN = \text{Frequency Rating} \times \text{Severity Rating} \times \text{Probability of Detection} \quad \text{Eq. (1)}$$

The calculation of the RPN ‘weighs’ the components in such a way as to identify critical components. In the gearbox supplier’s analysis, the Grease Lube Line, LSS Drywell and LSS Internal Oil Seal would be the top three as detailed in Chart 1.

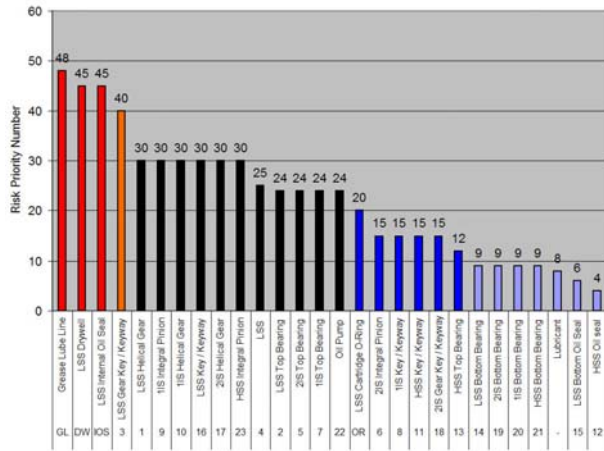

Chart 1. Risk Priority Number (RPN)

INSPECTION RESULTS

The inspection results are tabularized in Annex C – General Condition Assessment. Refer to Annex A - General Gearbox Schematic and Annex D – Photos, for reference to gearbox components.

EXTERNAL VISUAL INSPECTION

The remaining oil was drained from the gearbox, then nameplate information, low speed seal area and input shaft seal area were inspected. There was heavy grease leakage from the low speed shaft seal. The grease was discolored to black from the light green that was the original color. There was some rust on both low speed and input speed shaft but no significant damage was found. The shaft run-out and also endplay were within the specification. The shaft run-out on low speed shaft was actually 0.100mm and the shaft run-out on input shaft was 0.010mm.

INTERNAL VISUAL INSPECTION

After the external visual inspection, all external parts such as pump and piping were removed and the housing was disassembled for internal visual inspection. There was some slight wear on the gears, but all looked to be in good condition and no significant damage was observed. All bearings were found to be in good condition. After the internal visual inspection of the gears and input/intermediate bearings, the low speed shaft portion was disassembled in order to see the LSS

surface, LSS bearing, LSS oil seal and drywell baffle. The LSS had up to 5mm wear marks from the inner seal. The seal grooves, caused by seal wear on the LSS, were found to be acceptable. There was no other significant wear on the LSS at the bearing mounting. The QC Department independently inspected the shaft. All dimensions including runout were found to be within tolerance. The LSS oil seal where the grease came out did not have any significant damage such as softening or brittleness on the OD and lip. The OD of the seal had a dry ‘ring’, which is assumed to mean that no grease penetrated the seal OD. The QC Department also inspected the welding of the drywell baffle. No irregularities were reported.

OIL AND GREASE ANALYSIS

Samples of oil (from the sump) and grease (from the LSS bearing cavity) were sent to an independent laboratory for analysis. The oil and grease used for the gearboxes were of recommended viscosity and the condition was normal. See Annex F for Oil Sample Reports.

GREASE LUBE LINE INSPECTION

The piping for grease inlet and outlet was removed from the gearbox for the inspection. Upon removal, it was determined that the supply line was holding pressure (after 5 months of inside storage). A pressure test was conducted of grease supply and relief lines to determine if the lube lines had any blockages. Slow & steady pressure was applied up to 100 psi, failing to expel any grease. The piping surface was heated to 162 deg F by a gas burner and the grease exited with some force. The resulting grease composition was solid and pliable. Approximately 8-10 oz of the oil had totally separated from the soap, which had acted as a thick plug in the grease line. A further inspection of the grease lines for aerator 2 gearbox did not exhibit the same conditions. The grease was significantly less viscous.

POSSIBLE FAILURE MODE(S)

The position of the lube access points were requested by the aerator OEM in the original specification. The supply and relief line lengths were constructed to provide ease of access for routine maintenance. Based on the grease piping inspection, the oil separation from the grease could build a high pressure inside of the gearbox. The gearbox was operating in a cold location during an extended winter season. Under normal operation, the housing and bearing covers are warmed by friction from gears, bearing rollers and oil churning. There is some concern that the NLGI #2EP grease required for normal bearing lubrication which was in the external piping may not have benefitted from radiant heat of the gearbox or the immersion oil heater. Discussing the conditions with lubricant suppliers, the grease can separate the oil from soap base when it is subject to the cycle of hot and cold temperatures. From the application point of view, it was verified that there was excessive operating runout on the gearbox low speed shaft. It is assumed from previous inspection, that excessive shaft loads

are responsible for shaft movement. If the shaft movement is greater than the allowable deflection of the oil seal, the grease could seep out between the seal lip and shaft. Since there is no other quality and design concerns found except the grease lube line, the possible cause of grease leakage from the seal is mainly the excessive overhung load on the gearbox and less likely the build up of internal pressure due to grease property changes in cyclical temperature conditions. The gearbox supplier has assumed the shaft deflection also caused the wide seal mark on the LSS, from the inner seal, causing the seal to 'wobble' over a wide area. Annex D, Fig. 14. This is further confirmed by Aerator 2 gearbox which is an identical unit mounted in the same environmental conditions. No lubrication degradation, leakage or wide seal groove area has been discovered after the initial rebuild in Jan 2005.

In this case, no quality and assembly problems were found on the LSS Drywell and LSS Internal Oil Seal, however this FMEA tells the gearbox supplier that they have to be careful not only for manufacture and assembly, but also for application effects. Relatively simple clogs and/or grease separation could cause a failure, like the potential in our referenced issue. Extreme cold and warm temperature cycles may have detrimental effect on the lubricating grease. Providing consistent temperatures to the lubricant should eliminate this potential problem. FMEA has highlighted how each gearbox part could be a candidate for failure and provides us the opportunity to determine the root causes. The pressure test of the lube line may have never occurred if the application conditions were not considered in designing the Priority Assessment.

CONCLUSIONS

Through the inspection and failure analysis, the gearbox supplier has concluded the following:

No quality problems were found on the gearbox parts.

No assembly problems were found.

The cause of failure is likely application related.

The design and regrease intervals of the lubrication lines should be reevaluated for environmental considerations.

The evidence leads the gearbox supplier to conclude that the most likely root cause of failure was excessive over hung load on the gearbox low speed shaft which caused the shaft deflection and grease leakage at the low speed seal.

LESSONS LEARNED

FMEA tells the gearbox supplier that A) all the gearbox parts could be a candidate for the cause of failure and B) design is limited to clearly defined application information.

Normally the viscosity grade for gear oil is selected based on an ambient temperature but for the grease lube, it may not be selected as careful as gear oil. Lube system and the environment need to be considered thoroughly during lubricant selection.

A minimum bearing span specification has been instituted for aerator applications to provide a significantly larger margin of safety to accommodate unforeseen and unpredicted application variables. From this application and previous situations, a maximum 5:1 ratio of reducer bearing span to impeller length will be allowed with the standard bearing configuration. A ratio larger than 5:1 indicates that a drop bearing design is required.

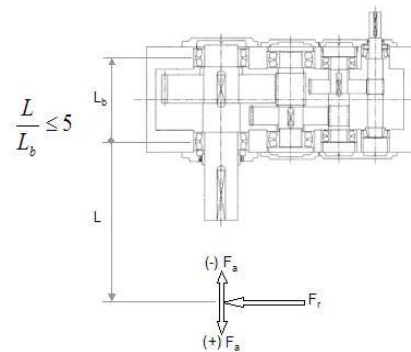

Figure 5. Bearing Span to Aerator Length

Acknowledgments

Bart Holmes, R&D Technician, Sumitomo Machinery Corp of America, Chesapeake, VA.

Safi Ahmed, Application Engineer, Sumitomo Machinery Corp of America, Glendale Heights, IL.

Charles Ritinski, Charles Embers, and Anthony Taylor, Sumitomo Drive Technologies – Engineering and Service Center, Chesapeake, VA.

Fred Mitchell, PE, Equipment Builder Engineer, ExxonMobil, Dublin, OH.

Arthur Pantelides, PhD, Director of Engineering and R&D, Sumitomo Machinery Corp of America, Chesapeake, VA.

References

[1] Jones, T., 2006, “Water-Wastewater Committee: Program Opportunities in the Municipal Sector: Priorities for 2006,” presentation to CEE June Program Meeting, Boston, MA., http://www.cee1.org/cee/mtg/6-06_ppt/jones.pdf

[2] Koyo Oil Seals & O-Rings, Cat. No. 701E, pp. 21

[3] Dennies, D.P., 2005, “How to Organize and Run a Failure Investigation”, ASM International, Ohio, Chaps. 3, 4, Glossary.

[4] McDermott, R.E., Mikulak, R.J., 2009, “The Basics of FMEA, 2nd Ed.”, Productivity Press, New York, Chap. 4

[5] Bloch, H.P. and Geitner, F.K., 1999, Machinery Failure Analysis and Troubleshooting, Elsevier, Houston, Chaps. 3, 4,11

ANNEX A

GENERAL GEARBOX SCHEMATIC

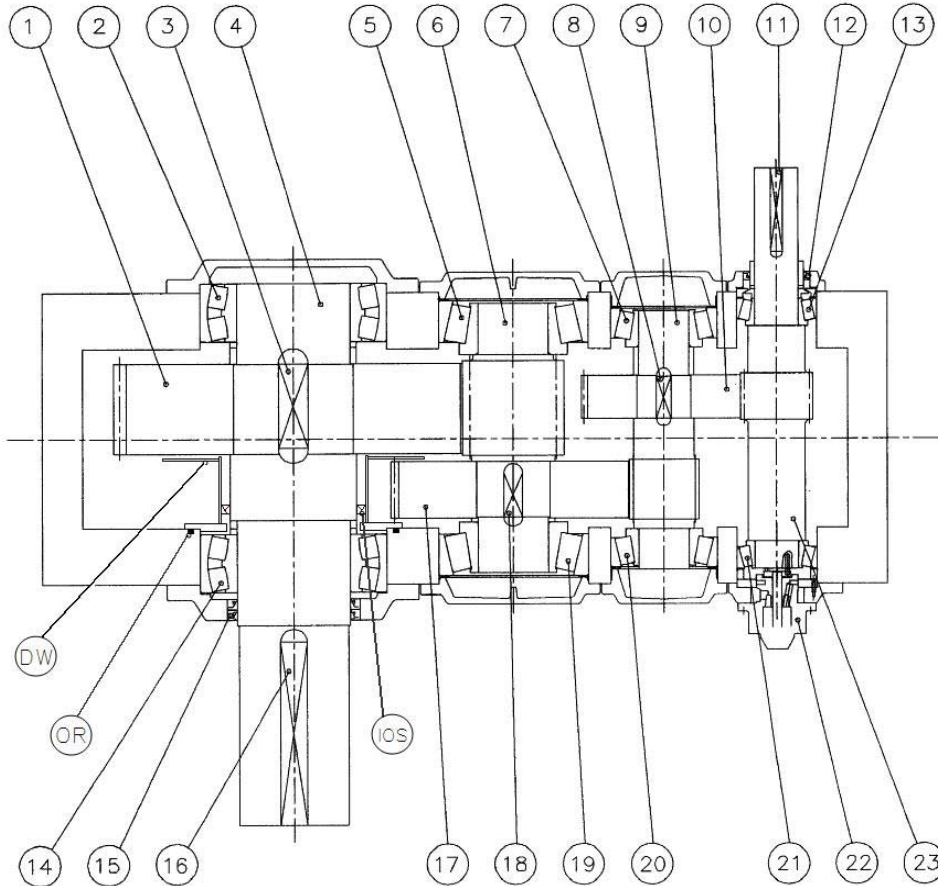

Position Ref #	Item
1	LSS Helical Gear
2	LSS Top Bearing
3	LSS Gear Key / Keyway
4	LSS
5	2IS Top Bearing
6	2IS Integral Pinion
7	1IS Top Bearing
8	1IS Key / Keyway
9	1IS Integral Pinion
10	1IS Helical Gear
11	HSS Key / Keyway
12	HSS Oil seal
13	HSS Top Bearing
14	LSS Bottom Bearing
15	LSS Bottom Oil Seal
16	LSS Key / Keyway
17	2IS Helical Gear
18	2IS Gear Key / Keyway
19	2IS Bottom Bearing
20	1IS Bottom Bearing
21	HSS Bottom Bearing
22	Oil Pump
23	HSS Integral Pinion
DW	LSS Drywell
IOS	LSS Internal Oil Seal
OR	LSS Cartridge O-Ring
GL	Grease Lube Line

ANNEX B

TABLE 1. FMEA RISK PRIORITY ASSESSMENT

Postion Ref #	Item	Potential / Probable			Current Controls	Risk Priority Number			
		Failure Modes	Cause of Failure	Effect of Failure		Frequency (Occurrence)	Severity	Detection	RPN
1	LSS Helical Gear	Excessive wear, scuffing, scoring, contact or bending fatigue; cracking, plastic deformation, fracture	Continuous overload, lack of lubricant, shock load, assembly	Noise, Vibration, Eventual catastrophic failure, stoppage of system (the Unit)	Quality Dept. Check Assembly Check Assembly Test	2	5	3	30
2	LSS Top Bearing	Pitting, scoring, fretting, fracture, excessive wear, burn, corrosion	Continuous overload, lack of lubricant, shock load, water, assembly, quality	Noise, Vibration, Eventual catastrophic failure, stoppage of system (the Unit)	Assembly Check Assembly Test	2	4	3	24
3	LSS Gear Key / Keyway	Excessive wear, plastic deformation, cracking, fracture	Material, assembly / fit, repetitive shock load	Eventual catastrophic failure, stoppage of system (the unit)	Assembly Check	2	4	5	40
4	LSS	Cracking, fracture	Material, design	Eventual catastrophic failure, stoppage of system (the unit)	Quality Dept. Check Assembly Check	1	5	5	25
5	2IS Top Bearing	Pitting, scoring, fretting, fracture, excessive wear, burn, corrosion	Continuous overload, lack of lubricant, shock load, water, assembly, quality	Noise, Vibration, Eventual catastrophic failure, stoppage of system (the Unit)	Assembly Check Assembly Test	2	4	3	24
6	2IS Integral Pinion	Excessive wear, scuffing, scoring, contact or bending fatigue; cracking, plastic deformation, fracture	Continuous overload, lack of lubricant, shock load, assembly	Noise, Vibration, Eventual catastrophic failure, stoppage of system (the Unit)	Quality Dept. Check Assembly Check Assembly Test	1	5	3	15
7	1IS Top Bearing	Pitting, scoring, fretting, fracture, excessive wear, burn, corrosion	Continuous overload, lack of lubricant, shock load, water, assembly, quality	Noise, Vibration, Eventual catastrophic failure, stoppage of system (the Unit)	Assembly Check Assembly Test	2	4	3	24
8	1IS Key / Keyway	Excessive wear, plastic deformation, cracking, fracture	Material, assembly / fit, repetitive shock load	Eventual catastrophic failure, stoppage of system (the unit)	Assembly Check	1	3	5	15
9	1IS Integral Pinion	Excessive wear, scuffing, scoring, contact or bending fatigue; cracking, plastic deformation, fracture	Continuous overload, lack of lubricant, shock load, assembly	Noise, Vibration, Eventual catastrophic failure, stoppage of system (the Unit)	Quality Dept. Check Assembly Check Assembly Test	2	5	3	30
10	1IS Helical Gear	Excessive wear, scuffing, scoring, contact or bending fatigue; cracking, plastic deformation, fracture	Continuous overload, lack of lubricant, shock load, assembly	Noise, Vibration, Eventual catastrophic failure, stoppage of system (the Unit)	Quality Dept. Check Assembly Check Assembly Test	2	5	3	30
11	HSS Key / Keyway	Excessive wear, plastic deformation, cracking, fracture	Material, assembly / fit, repetitive shock load	Eventual catastrophic failure, stoppage of system (the unit)	Assembly Check	1	3	5	15
12	HSS Oil seal	Hardening, cracking, leaking, deteriorating	Quality, assembly, environment	Water entry and contamination, eventual corrosion and potential catastrophic failure	Assembly Check	1	2	2	4
13	HSS Top Bearing	Pitting, scoring, fretting, fracture, excessive wear, burn, corrosion	Continuous overload, lack of lubricant, shock load, water, assembly, quality	Noise, Vibration, Eventual catastrophic failure, stoppage of system (the Unit)	Assembly Check Assembly Test	2	3	2	12
14	LSS Bottom Bearing	Pitting, scoring, fretting, fracture, excessive wear, burn	Continuous overload, lack of lubricant, shock load, water, assembly, quality	Noise, Vibration, Eventual catastrophic failure, stoppage of system (the unit)	Assembly Check Assembly Test	1	3	3	9
15	LSS Bottom Oil Seal	Hardening, cracking, leaking, deteriorating	Quality, assembly, environment	Leakage leading to eventual lubrication loss and potential unit failure	Assembly Check	2	3	1	6
16	LSS Key / Keyway	Excessive wear, plastic deformation, cracking, fracture	Material, assembly / fit, repetitive shock load	Potential series failure, stoppage of system (the unit); potential damage to external auxiliary equipment	Assembly Check	2	3	5	30
17	2IS Helical Gear	Excessive wear, scuffing, scoring, contact or bending fatigue; cracking, plastic deformation, fracture	Continuous overload, lack of lubricant, shock load, assembly	Noise, Vibration, Eventual catastrophic failure, stoppage of system (the unit)	Quality Dept. Check Assembly Check Assembly Test	2	5	3	30
18	2IS Gear Key / Keyway	Excessive wear, plastic deformation, cracking, fracture	Material, assembly / fit, repetitive shock load	Eventual catastrophic failure, stoppage of system (the unit)	Assembly Check	1	3	5	15
19	2IS Bottom Bearing	Pitting, scoring, fretting, fracture, excessive wear, burn	Continuous overload, shock load, assembly, quality	Noise, Vibration, Eventual catastrophic failure, stoppage of system (the unit)	Assembly Check Assembly Test	1	3	3	9
20	1IS Bottom Bearing	Pitting, scoring, fretting, fracture, excessive wear, burn	Continuous overload, shock load, assembly, quality	Noise, Vibration, Eventual catastrophic failure, stoppage of system (the unit)	Assembly Check Assembly Test	1	3	3	9
21	HSS Bottom Bearing	Pitting, scoring, fretting, fracture, excessive wear, burn	Continuous overload, shock load, assembly, quality	Noise, Vibration, Eventual catastrophic failure, stoppage of system (the unit)	Assembly Check Assembly Test	1	3	3	9
22	Oil Pump	Not pumping oil	Quality, mechanical connection shear, blockage	Top bearing lube starvation, bearing failure leading to unit stoppage	Assembly Check	2	4	3	24
23	HSS Integral Pinion	Excessive wear, scuffing, scoring, contact or bending fatigue; cracking, plastic deformation, fracture	Continuous overload, lack of lubricant, shock load, assembly	Noise, Vibration, Eventual catastrophic failure, stoppage of system (the unit)	Quality Dept. Check Assembly Check Assembly Test	2	5	3	30
DW	LSS Drywell	Not maintaining oil out of bottom bearing cartridge	Material, design, quality	Flooding bottom bearing cartridge, leading to possible leakage out of unit, Lubrication loss, and potential unit failure	Assembly Check	3	3	5	45
IOS	LSS Internal Oil Seal	Hardening, cracking, leaking, deteriorating	Quality, assembly	Flooding bottom bearing cartridge, leading to possible leakage out of unit, Lubrication loss, and potential unit failure	Assembly Check	3	3	5	45
OR	LSS Cartridge O-Ring	Hardening, cracking, leaking, deteriorating	Quality, assembly	Leakage out of unit, Lubrication loss, and potential unit failure	Assembly Check	2	2	5	20
GL	Grease Lube Line	Not lubricating properly	Design, assembly, clog with foreign material, lack of lubricant property	Internal pressure build up, Leakage out of piping, and potential unit failure	Assembly Check	3	4	4	48
-	Lubricant	Not lubricating properly – performance, location	Water and / or other foreign material contamination	Eventual system (unit) catastrophic failure	None	1	4	2	8

LSS = Low Speed Shaft, Output Shaft
 2IS = 2nd Intermediate Shaft
 1IS = 1st Intermediate Shaft
 HSS = High Speed Shaft

Frequency
 1 = Remote (failure unlikely)
 2 = Low (few failures)
 3 = Moderate (occasional failures)
 4 = High (repeated failures)
 5 = Very High (inevitable failure)

Severity
 1 = Minor
 2 = Low
 3 = Moderate
 4 = High
 5 = Very High

Detection
 1 = Certainty – WILL Detect
 2 = High
 3 = Moderate
 4 = Low
 5 = Certainty – Will NOT Detect

ANNEX C

TABLE 2. GENERAL CONDITION ASSESMENT REPORT

Ref.	Item	Inspection Condition	Dimension Check	Photo Doc.	Special Notes
1	LSS Helical Gear	A B C D F	YES / NO	YES / NO	Gear Checker
2	LSS Top Bearing	A B C D F	YES / NO	YES / NO	Disassemble only after thorough check
3	LSS Gear Key / Keyway	A B C D F	YES / NO	YES / NO	Check potential "stepping"
4	LSS	A B C D F	YES / NO	YES / NO	Metallurgy of critical cross-section(s)
5	2IS Top Bearing	A B C D F	YES / NO	YES / NO	Disassemble only after thorough check
6	2IS Integral Pinion	A B C D F	YES / NO	YES / NO	Gear Checker
7	1IS Top Bearing	A B C D F	YES / NO	YES / NO	Disassemble only after thorough check
8	1IS Key / Keyway	A B C D F	YES / NO	YES / NO	Check potential "stepping"
9	1IS Integral Pinion	A B C D F	YES / NO	YES / NO	Gear Checker
10	1IS Helical Gear	A B C D F	YES / NO	YES / NO	Gear Checker
11	HSS Key / Keyway	A B C D F	YES / NO	YES / NO	Check potential "stepping"
12	HSS Oil seal	A B C D F	YES / NO	YES / NO	
13	HSS Top Bearing	A B C D F	YES / NO	YES / NO	Disassemble only after thorough check
14	LSS Bottom Bearing	A B C D F	YES / NO	YES / NO	Disassemble only after thorough check
15	LSS Bottom Oil Seal	A B C D F	YES / NO	YES / NO	
16	LSS Key / Keyway	A B C D F	YES / NO	YES / NO	Check potential "stepping"
17	2IS Helical Gear	A B C D F	YES / NO	YES / NO	Gear Checker
18	2IS Gear Key / Keyway	A B C D F	YES / NO	YES / NO	Check potential "stepping"
19	2IS Bottom Bearing	A B C D F	YES / NO	YES / NO	Disassemble only after thorough check
20	1IS Bottom Bearing	A B C D F	YES / NO	YES / NO	Disassemble only after thorough check
21	HSS Bottom Bearing	A B C D F	YES / NO	YES / NO	Disassemble only after thorough check
22	Oil Pump	A B C D F	YES / NO	YES / NO	Disassemble only after thorough check
23	HSS Integral Pinion	A B C D F	YES / NO	YES / NO	Gear Checker
DW	LSS Drywell	A B C D F	YES / NO	YES / NO	Check fabrication quality
IOS	LSS Internal Oil Seal	A B C D F	YES / NO	YES / NO	
OR	LSS Cartridge O-Ring	A B C D F	YES / NO	YES / NO	
GL	Gease Lube Line	A B C D F	YES / NO	YES / NO	Check flowability (Pressure test)
-	Lubricant	A B C D F	Not Applicable	-	Lab Analysis

Inspection Condition

- A = Brand New (Initial Supply)
- B = Good
- C = OK
- D = Non Destructive Failure
- F = Destructive Failure

Dimension Check

- YES = Checked at Initial Supply
- YES = Checked at Initial Supply and also Factory Inspection

ANNEX D

PHOTOS



Figure 6. Aerator 1 Basin Sediment



Figure 9. Added Weight to Re-Balace Aerator 1



Figure 7. Detail of Fibrous Debris in Aerator 1 Basin



Figure 10. Low Speed Seal Area at Factory Inspection



Figure 8. Example of Broken Impeller tip for Aerator 1

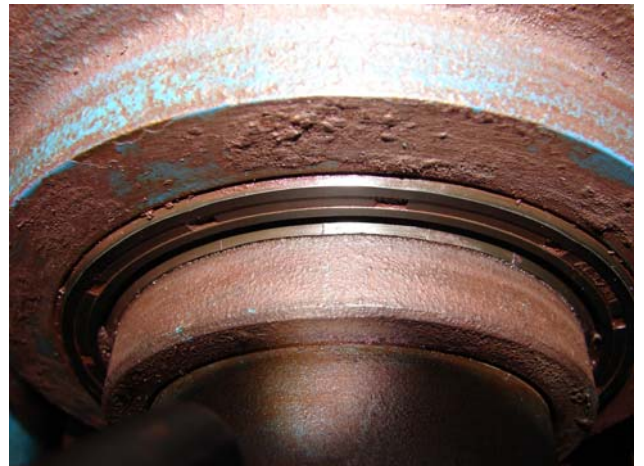

Figure 11. Input Shaft Seal Area at Initial Inspection

ANNEX D

PHOTOS CONTINUED

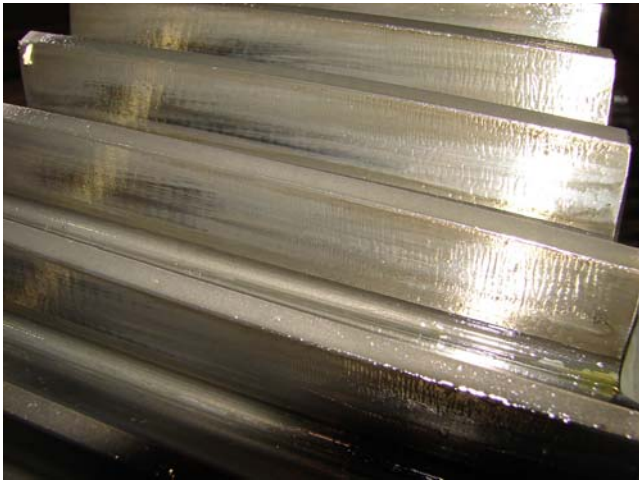

Figure 12. Low Speed Gear

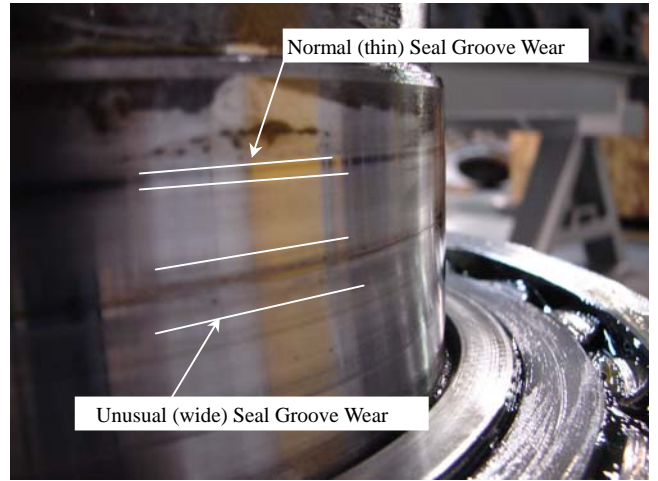

Figure 14. Low Speed Shaft Seal Contact Area



Figure 13. Low Speed Shaft Assembly

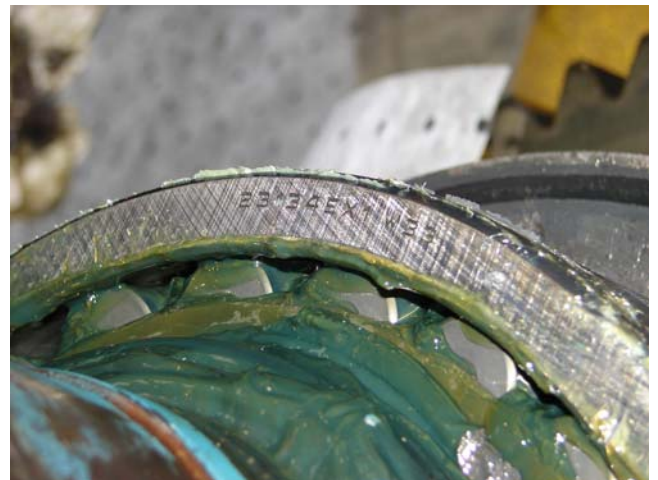

Figure 15. Low Speed Bearing

ANNEX D

PHOTOS CONTINUED



Figure 16. Low Speed Seal and Bearing Cover



Figure 18. Low Speed Grease Supply Line

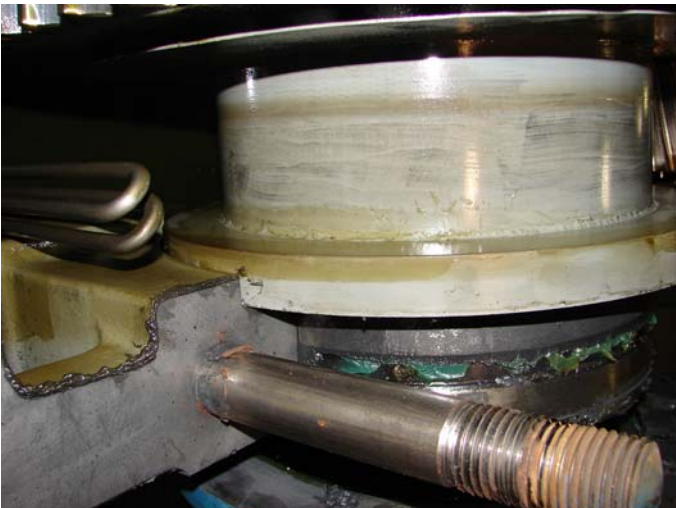

Figure 17. Drywell Chamber



Figure 19. Low Speed Grease Relief Line

ANNEX E

INITIAL FACTORY INSPECTION REPORT (FIRST PAGES ONLY)

SUMITOMO Inspection Notes
 MACHINERY CORPORATION OF AMERICA

Return # : Model # PVD9080P3-RL-48.222 Serial # :
 Date 1/20/05 Factory Order # : Product ID :
 Name of Technician / Engineer Kurt Oda / Chief Engineer Paramax Products FR-P-05001

SUMITOMO Inspection Report
 MACHINERY CORPORATION OF AMERICA

Return # N/A Model # PVD9080P3-RL-48.222
 Date 05/21/07 Factory Order # : Product ID :
 Name of Technician / Engineer Thomas Tanaka / Chief Engineer Paramax Products Report# FRP07002

Customer: Application: Aerator

The customer reported grease leakage from LSS oil seal. The gearbox was returned to Chesapeake facility for inspection and repair.

1. Gearbox condition
 LSS Oil seal: LSS oil seal shows wear.
 Drywell seal: Light wear was observed.
 Drywell O-ring: Good condition.
 LS Shaft: Oil seal contact surface has reasonable wear. Fair condition.
 Helical Pinions and Gears: Good condition.
 Housing and Covers: Good condition.
 Bearings: No significant damage was observed.

2. Possible cause of failure
 The grease remained in the LSS drywell and is softer than normal. It is considered oil contaminated the grease. The LS gear keyway has a height clearance that is the normal design and special designed spacer supposed to cover upper exit of keyway. However, the spacer was designed incorrectly. It is our opinion that pumping oil feeds to the upper surface of LS gear. Oil comes down along the keyway and is accumulated in the drywell. Oil passed through drywell seal which is designed as a grease seal, and got into grease room. For some reason, high probability of excessive grease supply, LSS oil seal was pushed by inner pressure and allowed to leak soft grease to outside of gearbox.

3. Repair detail
 Design change parts: Spacer shape was changed to cover keyway clearance to protect oil leak.
 Replacement parts: All oil-seals, Drywell seal, LSS spacer.

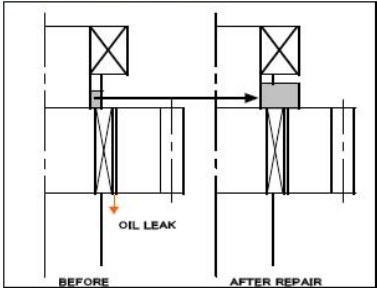

Determination: Warranty repair.

Customer: Application: Aerator

1. Gearbox condition
 Low speed shaft drywell portion: Grease leakage from the bottom oil seal. Grease color was black.
 Low speed shaft: Approx. 4 mm radial shaft run-out at coupling hub was observed.
 Grease outlet: No leakage since it was changed to a plug.
 Housing / Covers: Good condition*
 Air breather / Oil pump / Piping: Good condition.
 Noise level: Good.

*Surface temperature of bearing cover [deg F]
 S/N#:

Location	LSS	INT shaft 1	INT shaft 2	HSS	Oil sump
Bottom	113	118	122	127	112
Top	114	115	116	119	(Housing surface)

 S/N#:



Location	LSS	INT shaft 1	INT shaft 2	HSS	Oil sump
Bottom	116	120	122	123	110
Top	106	108	114	112	(Housing surface)



2. Possible cause of failure
 We suspect that excessive shaft movement was caused by fluctuating load and/or excessive over load. We found at the job site that this type of aerator is a non-supported impeller type. With these possible deficiencies, the gearbox could see increased output shaft movement, overloading and potential vibration damage.
 We feel that the grease leakage from the relief valve was most likely due to an abnormally high internal pressure of gearbox drywell sump cavity. We further feel that the increase of internal pressure has two possible causes.
 The most likely cause is thermal expansion of grease during operation. Our design concept is for the relief valve to provide adequate relief of the internal pressure. According to physical gearbox tests conducted separately on similar gearbox configurations, we observed that on some occasions the relief valve did not release internal pressure. It was found that in some cases there simply is too much grease in the drywell chamber. Additional, but less likely is the pressure by some grease guns contributes to increasing internal pressure. As soon as some quantity of grease comes out from the relief valve, internal pressure should

ANNEX F

OIL AND GREASE TRIBOLOGY REPORTS FOR AERATOR 1 GEARBOX

Test Results show no abnormalities of Grease or Oil Samples taken for final FMEA inspection.

UNIT ID RVA16696 GREASE SECOND ID #1 DRYWELL GREASE UNIT TYPE GREASE APPLICATION PLANT/INDUSTRIAL		 POLARIS Laboratories, LLC		COMPANY INFORMATION POLARIS PROMO LINDA PASCALI 215-579-7938/CELL 317-753-0510 146 OAK RIDGE DRIVE LANGHORNE, PA 19047	
ACCOUNT NUMBER POLARI05090000 DATE SAMPLED N/A DATE RECEIVED 04/30/09 DATE COMPLETED 05/04/09		 <p>OVERALL SEVERITY OF REPORT based on comments, not individual flags</p>		LAB # 160510	
TRACKING # SUMITOMO MANUFACTURER/MODEL MOBIL LUBE MFR MOBILUX EP1 LUBE TYPE - GRADE 0 MICRON RATING NONE FILTER TYPE 0.00 SUMP CAPACITY 0 HYD SYSTEM PRESSURE 0 FLUID ADDED				LOCATION I ANALYST RNF	
FLUID ANALYSIS REPORT - 877-808-3750					
COMMENTS [No opinions expressed on this data; Please specify the application (bearing, gear, roller, shoe, etc.);]					
WEAR METALS PPM		CONTAMINANT METALS - PPM		MULTI-SOURCE METALS - PPM	
SAMP #	CHROMIUM	ALUMINUM	COPPER	IRON	WATER
1	67	0	0	0	0
SAMP #	DATE SAMPLED	UNIT TIME	FILTRATION	FILTRATION	SUMMARY
1	04/30/09	U	U		

UNIT ID RVA16696 SECOND ID #1 OIL UNIT TYPE GEAR - BEARING APPLICATION PLANT/INDUSTRIAL		 POLARIS Laboratories, LLC		COMPANY INFORMATION POLARIS PROMO LINDA PASCALI 215-579-7938/CELL 317-753-0510 146 OAK RIDGE DRIVE LANGHORNE, PA 19047	
ACCOUNT NUMBER POLARI05090000 DATE SAMPLED N/A DATE RECEIVED 04/30/09 DATE COMPLETED 05/05/09		 <p>OVERALL SEVERITY OF REPORT based on comments, not individual flags</p>		LAB # 160518	
TRACKING # SUMITOMO MANUFACTURER/MODEL MOBIL LUBE MFR MOBILGEAR 600 XP ISO 220 LUBE TYPE - GRADE 0 MICRON RATING NONE FILTER TYPE 0.00 SUMP CAPACITY 0 HYD SYSTEM PRESSURE 0 FLUID ADDED				LOCATION I ANALYST FLG	
FLUID ANALYSIS REPORT - 877-808-3750					
COMMENTS [Data indicates no abnormal findings. Resample at normal interval; Please provide unit model number so we may compare data to the proper standards for this unit; Please provide this units sump capacity with next sample;]					
WEAR METALS PPM		CONTAMINANT METALS - PPM		MULTI-SOURCE METALS - PPM	
SAMP #	CHROMIUM	ALUMINUM	COPPER	IRON	WATER
1	4	0	0	0	0
SAMP #	DATE SAMPLED	UNIT TIME	FILTRATION	FILTRATION	SUMMARY
1	04/30/09	U	U		